

Model #

# 7031GDRC

## Northgate Mirror

Glazed Dark Chestnut Finish

*Assembly Instructions*

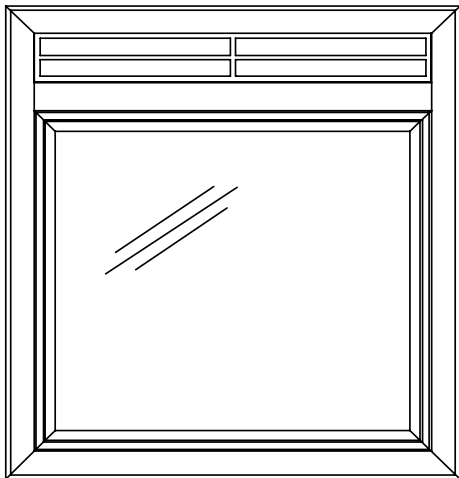

### IMPORTANT NOTES:



- For normal household use only. *Not* recommended for commercial use.
- Handle the mirror with care. Glass is fragile.
- Before you begin your project, completely read the Assembly Instructions.
- Store this item: 1- in its box; 2- in a dry place; 3- in temperatures that range from 40°F to 90°F (not on a cold and possibly damp cement floor).
- Periodically inspect your furniture for any loose glue joints, screws or any other problem that might affect the stability of your furniture. Tighten or repair as needed.

**DESIGN SUBJECT TO CHANGE WITHOUT NOTICE**

### **Congratulations!**

*This fine piece of furniture will make a gorgeous addition to your home. For the best results, read the Assembly Instructions before you begin your project.*



**CALL US FIRST!** *Do not return this item to the store.*

**Service Policy:** We will replace any part that is defective, missing or damaged during assembly. For a replacement part, directly contact Whittier Wood Products customer service department by phone, fax, mail or email.

**Hours:** Our friendly customer service staff can be reached Monday-Friday 7:00 a.m. to 5:00 p.m. (Pacific Time). You may leave a message 24 hours a day, seven days a week.

**To Order:** Provide the finish and furniture model number (upper portion of this page), the part letter, production code, quantity needed, reason for replacement and your full name, address and telephone number.

*Parts ship from our Eugene, Oregon factory within one or two business days from the time we receive your request. Please allow five to ten business days for delivery.*

**800-653-3336** • Outside the U.S. or Canada: 541-687-0213 • Fax: 541-687-2060  
www.whittierwood.com • P.O. Box 2827 • Eugene, Oregon 97402, U.S.A.

**Whittier  
Wood**  
FURNITURE

P.O. Box 2827  
Eugene, OR 97402 USA











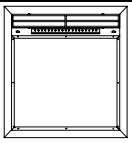
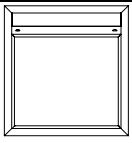

Production Code:

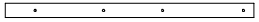
VN

12/11

## 7031GDRC Northgate Mirror Parts List

Please identify the parts and check that quantities received match those on this list.  
If you need to replace a part, refer to the following letter and part name.

Part	Description		Quantity
A	Mirror Assembly		1
B	Mirror Frame		1
C	Mirror (attached)		1
D	Mirror Support Rail (attached)		2
E	Mirror Support Stile (attached)		2
F	Mirror Support		2
G	Mirror Accent (attached)		1
H	Mirror Wall Bracket		2 (1 attached)
J	#6 x 3/4" Brass Flat Head Screw (inserted)		20
K	#8 x 1-1/4" Pan Head Screw (inserted)		2
L	#8 x 1-3/4" Pan Head Screw		2
M	M4 x 41 mm Machine Screw		4
N	Pad Strip		3
O	#7 x 1-1/2" Black Pan Head Screw		4

# 7031GDRC Northgate Mirror

## Assembly Instructions

**Tools Required:** Phillips Screwdriver, Tape Measure, Pencil

You have the option of attaching your Mirror to the wall or to the 7018 Northgate 8-Drawer Dresser. To attach the Mirror to a wall, follow steps 1-3. To attach the Mirror to the Dresser, follow steps 4-6.

1. Determine where you want the bottom of your mirror to end and draw a faint pencil line on the wall. Using a tape measure, measure up 31" from that line. Draw another faint line. The top line is where you will attach the Mirror Wall Bracket (H). If you like, you may erase the faint bottom pencil mark. See Figure 1.

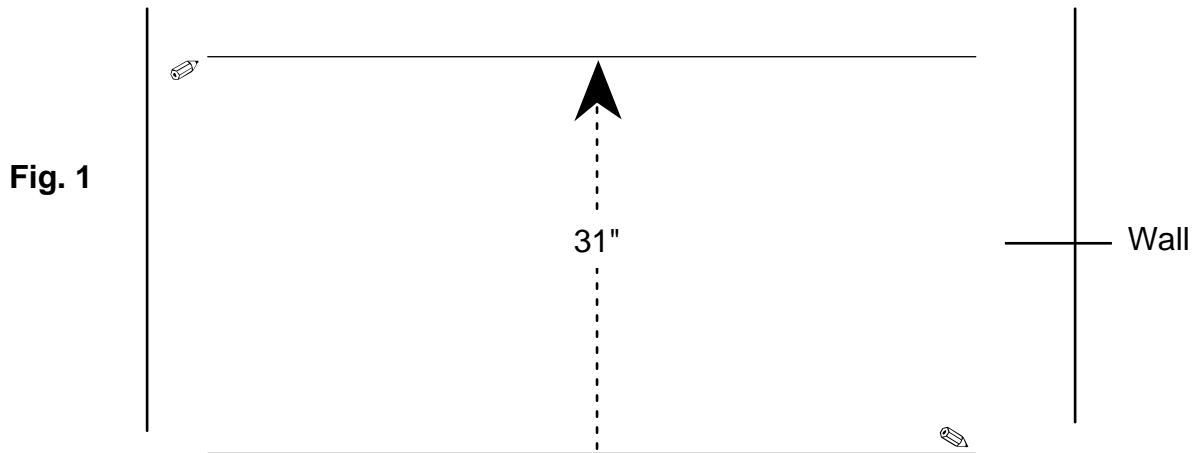

2. Locate two studs in the wall behind the space where you want to hang your Mirror. Affix the Mirror Wall Bracket (H) to the studs with two #8 x 1-3/4" Pan Head Screws (L). If you cannot locate two studs, purchase the proper wall attachment hardware for your type of wall and secure the bracket. See Figure 2.

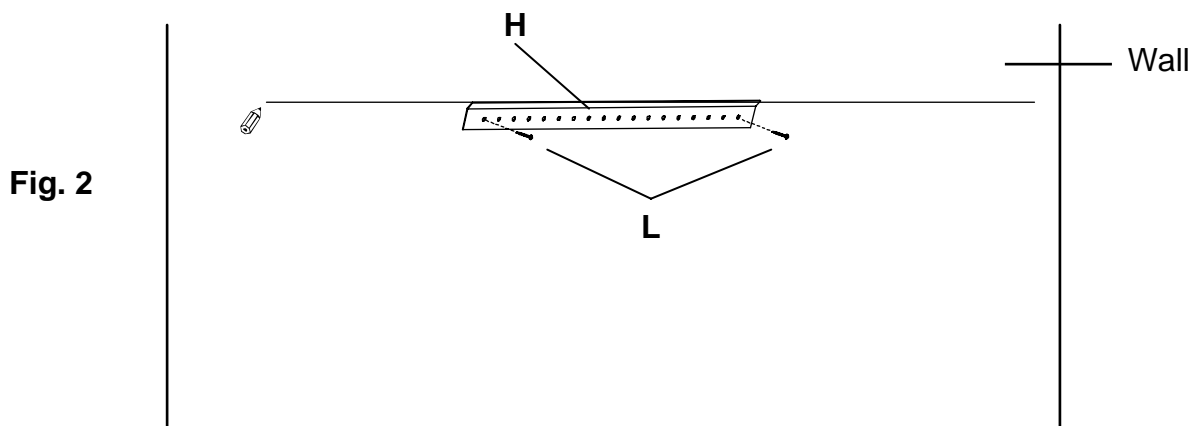
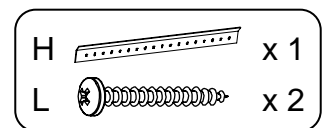

# 7031GDRC Northgate Mirror

## Assembly Instructions

3. NOTE: The Mirror Wall Bracket (H) angles out at the top. When you hang your Mirror, the bracket that is attached to the back of the Mirror fits over the angled part of the Mirror Wall Bracket (H). See Figure 3.

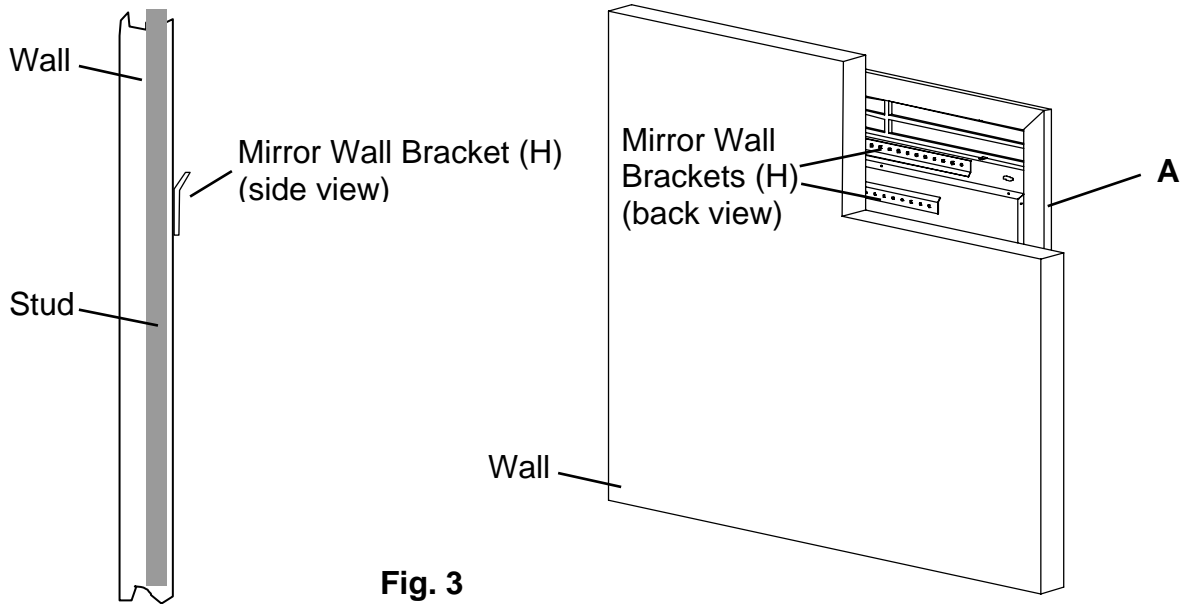

Fig. 3

4. If you are attaching the Northgate Mirror to the back of a 7018 Northgate 8-Drawer Dresser, follow steps 4-6. Using the predrilled holes on the back of the Dresser as guides, attach the two Mirror Supports (F) with four M4 x 41 Machine Screws (M). See Figure 4.

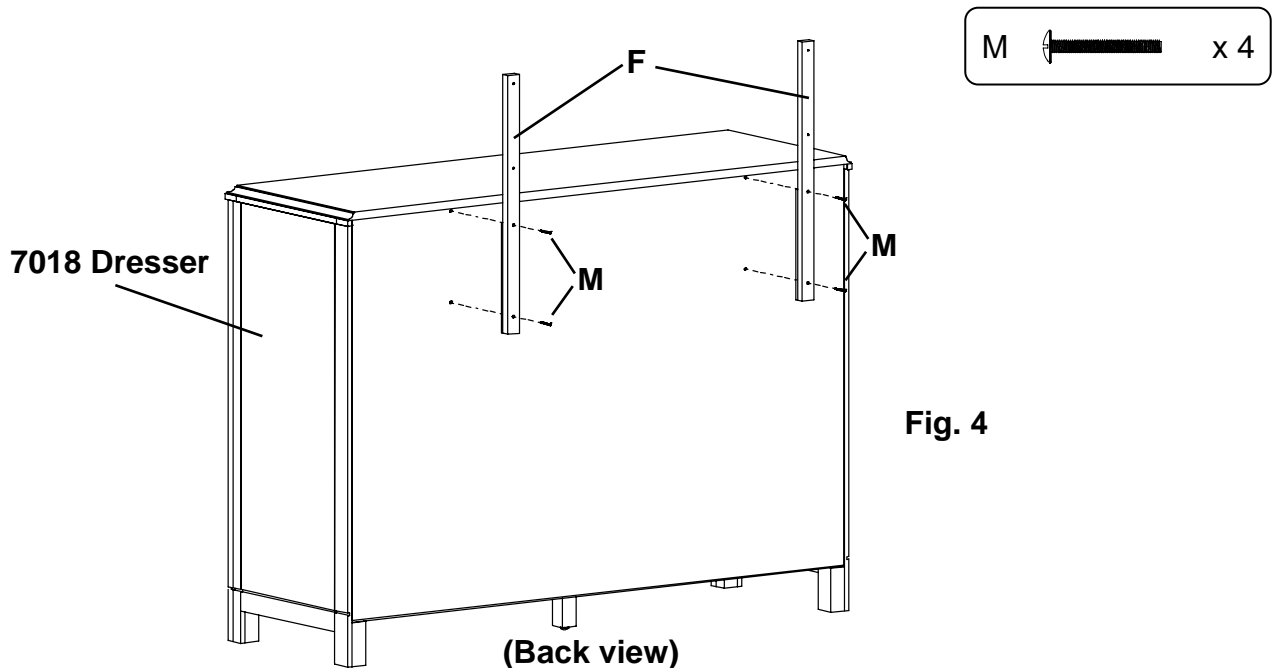

Fig. 4

# 7031GDRC Northgate Mirror

## Assembly Instructions

---

5. Peel off the backings on the Pad Strips (N) and apply them to the bottom of the Mirror Assembly (A). See Figure 5

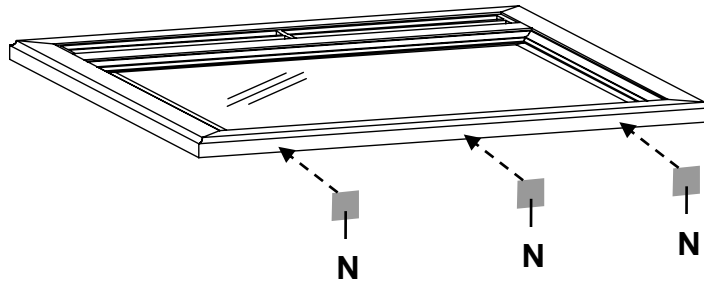

Fig. 5

6. Place the Mirror on top of the Dresser and attach it to the Mirror Supports (F) with four #7 x 1-1/2" Black Pan Head Screws (O). See Figure 6.

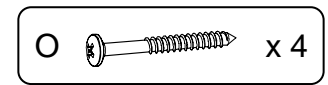
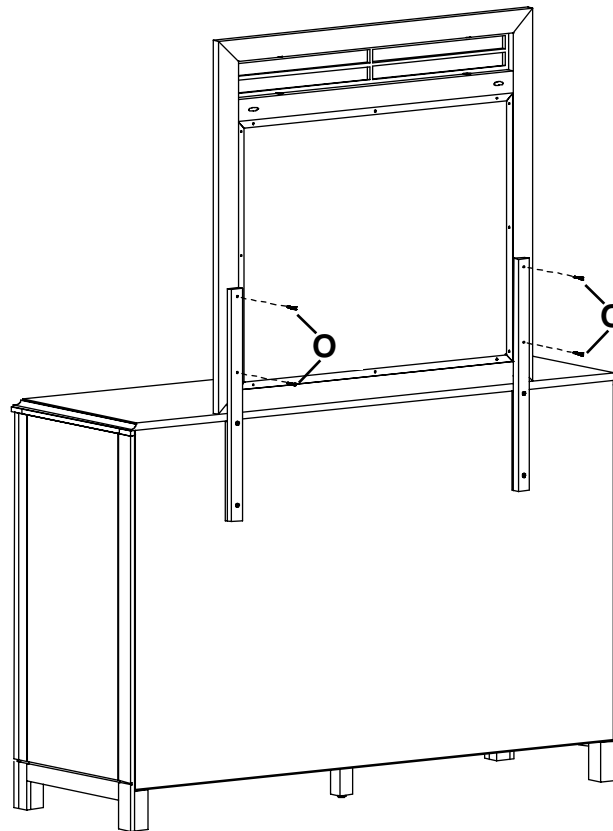

Fig. 6